



# ENVOY 3 EQUIP PLUS

---

SOLAR AUDIO PLAYER  
USER MANUAL

# TABLE OF CONTENTS

---

Easy Start	1
Turning the Player On/Off	3
The LCD Screen	4
Selecting Playback Channels	5
Navigating During Playback	6
Playback Screen	8
File Playback Information	9
Radio	11
Radio Screen	13
Speed Control	14
Speed Control Screen	16
LED Torch	17

Pausing/Bookmarking	17
Earphones, Speakers and Volume	18
Using the MicroSD Card	20
Resetting Player Defaults	23
Full Player Reset	24
The Menu System	25
The Menu System Screens	27
Charging Instructions	36
Charging Screen	37
Battery Care	38
Charging/Communication Modes	39
Problems With the Player?	42
Warnings	43
Reset Button	44

## EASY START

---

Press and hold the power button until the player chimes and the LCD screen turns on.  
The player will begin to play automatically.



or



## TURNING THE PLAYER ON/OFF

---

Press  in the top center of the keypad for 2 seconds to turn the player on (the LCD screen turns on and the player chimes). The welcome screen is displayed and audio playback/radio will begin immediately.

HELLO

Press and hold  for 2 seconds to turn the player off.

The player will chime again, show the shutdown screen and the LCD screen will turn off.

GOODBYE

*<sup>1</sup>The player will remember its last mode and playback position/band & frequency when turned off.*

## THE LCD SCREEN

---

This player is unique in that it provides complete information and control via the LCD screen with an interactive menu system.

The screen has a backlight, which is activated when the player is turned on, turned off, the menu is accessed or any time  is clicked. The backlight turns off automatically after 30 seconds of inactivity.

The information on the screen is always current as modes, content and settings change.

For more detail, see illustrations of various screens throughout this manual.

## SELECTING PLAYBACK CHANNELS



---

 The player supports up to 3 Channels for onboard memory and up to 2 Channels for microSD.

For both memory sources, there should be at least one of Channels 001 and 002 containing audio content.

When in playback mode, a 2-second press on  will navigate to the last playback position of the *other* Channel (if present).

Channel 000 (optional/onboard only) is typically reserved for a player introduction and/or audible user manual. If a Channel 000 is present, playback will always begin from it when the player is first turned on (or after player is reset).

When in playback from onboard or microSD memory, a 2-second press on  and  together will navigate<sup>1</sup> to Channel 000 in onboard memory (if present).

From Radio Mode, a 2-second press on  will resume at the prior position in onboard memory.



<sup>1</sup>*During onboard playback - to the last playback position. During microSD playback - to the beginning.*



## NAVIGATING DURING PLAYBACK



---

Each Channel is subdivided into one or more Sections, containing one or more Books, containing one or more Chapters.

Click  to skip to the next Section within the current Channel.

Click  or  to skip backward or forward one Book. A 2-second press will skip 5 Books at a time. Press and hold will continue until the button is released or the beginning/end of the Section is reached.

Click  or  to skip backward or forward one Chapter. A 2-second press will skip 5 Chapters at a time. Press and hold will continue until the button is released or the beginning/end of the Book is reached.

Click  or  to jump backward or forward 20 seconds<sup>1</sup> in the current file. Press and hold<sup>3</sup> will perform a fast rewind/fast forward (in 60-second increments<sup>1</sup>) until the button is released or the beginning/end of the file is reached.

To quickly return to the start of a Channel, while in Pause Mode press  for 2 seconds.

<sup>1</sup>Actual time may vary.

<sup>2</sup>While in audio playback mode, the Playback screen is displayed.

<sup>3</sup>During "press and hold", a scale will be displayed on the bottom line of the screen showing the current playback position within the total play time of the current file.

## PLAYBACK SCREEN

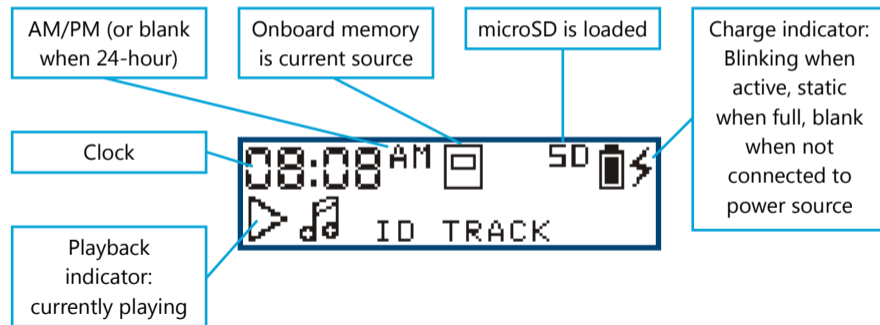

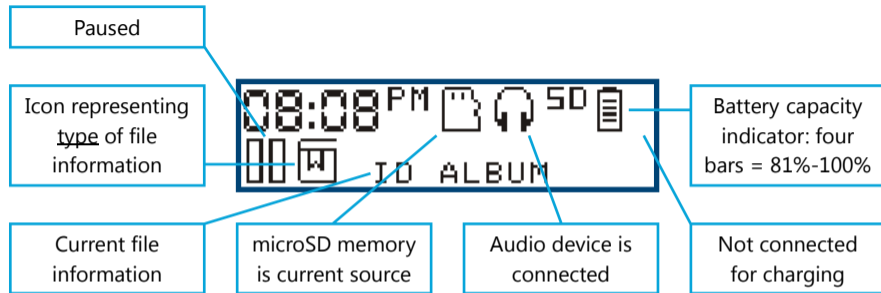

## FILE PLAYBACK INFORMATION

Available audio file metadata tags are displayed for each file in the following way:

- Track info: 🎵 + ID3 Track Name
- If Track Name is blank or missing, 🎵 + Filename.extension

- Album Info: 📀 + ID3 Album Name
- If ID3 Album Name is blank or missing, the field is skipped
- Artist info: 👤 + ID3 Artist Name
- If ID3 Artist Name is blank or missing, the field is skipped
- If ID3 metadata is completely missing
- The player will display only 🎵 + Filename.extension
- If any tag text<sup>1</sup> is longer than the screen area<sup>2</sup>, it scrolls from right to left
- The field will show for 3 seconds before scrolling begins
- Once scrolling has finished the next field is displayed



<sup>1</sup>Any tag text longer than 44 characters will be truncated.

<sup>2</sup>Typically about 13 characters.



## RADIO



---



When in playback mode, a 2-second press on  will put the player in radio mode (player will chime). The radio will begin to play from the last band used and the last frequency set.



If already in Radio mode, a click on  will cycle through the 3 bands available: FM, AM and SW. While in Radio Mode, a 2-second press on  will resume Playback Mode from the last position in onboard memory.

<sup>1</sup>While in Radio mode the Radio screen is displayed.

Click  or  to decrease/increase the frequency by a pre-set value<sup>3</sup> for the current band. A 2-second press will scan for the previous/next station of the current band. The frequency display will update as it changes.

When the scan reaches the beginning/end of the band's frequency range<sup>4</sup> the player will chime. An additional click will loop and continue the scan from the beginning/end respectively. To stop an active scan<sup>5</sup>, click on ,  or .

The    buttons may be pre-programmed with individual default frequencies per band. A click on each will tune the radio to the setting for that button. A 2-second press will set (or reset) that button to the current frequency.

<sup>2</sup>When the frequency is tuned to one of the programmable buttons (  ) , that button's symbol will be displayed on the screen.

<sup>3</sup>See Radio Band Spacing Screen for details.

<sup>4</sup>FM: 64.0-108.0 MHz, AM: 520-1720 kHz, SW: 2300-26100 kHz

<sup>5</sup>While scanning is active, you cannot change mode or turn the player off.



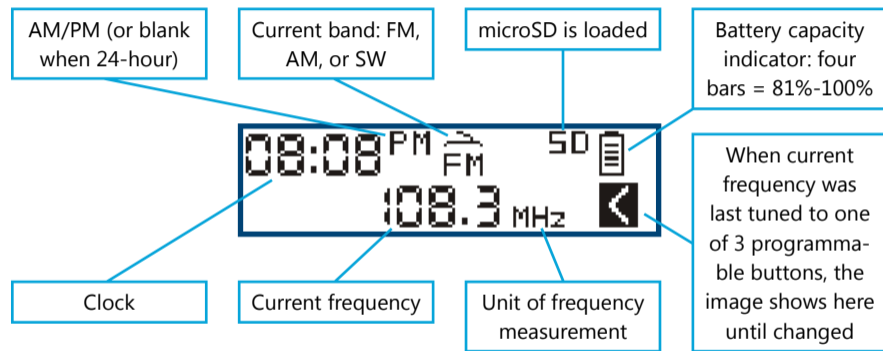

## RADIO SCREEN





## SPEED CONTROL

A 2-second press on  will emit a chime and place the player in speed control mode, allowing you to adjust the audio playback speed.

<sup>1</sup>While in speed control mode, the speed control adjustment screen is displayed.

A click on  or  will adjust playback speed by one level. Press and hold will decrease/increase until the minimum (-8) or maximum (+8) speed is reached.

Click  again to exit and save the setting. Pressing any other button will exit speed control mode *without* saving changes.

To reset the speed to normal (+0), enter speed control mode, then press  again for 2 seconds. Player will return to playback mode at normal speed.

<sup>2</sup>The Speed setting persists when changing modes or after turning the player off.



<sup>3</sup>The Speed setting applies to both onboard and microSD playback.

<sup>4</sup>The Speed Control button is only active during audio playback and may be set while playback is active or paused.

<sup>5</sup>Speed Control may also be set via the Settings Menu.

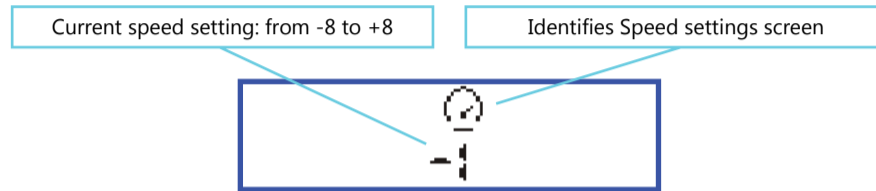
## SPEED CONTROL SCREEN



- This is the screen that is displayed when entering Speed Control Mode from playback .
- The same screen is accessible from the Player Settings Menu by selecting the  icon.

<sup>1</sup>Speed Control only works correctly with MP3, WAV and WMA type audio files!

## LED TORCH

---

Use  to control the LED Torch and its intensity. Each click will change the intensity as follows:



**Low > Medium > High > OFF**



Press and hold  to turn on the Torch in high intensity. The Torch will stay on until the button is released.

<sup>1</sup>*The Torch may be used while other functions are active or player is off.*

## PAUSING/BOOKMARKING

---

While in audio playback mode, click  to pause playback. The  icon is displayed.

To resume, click  again. The  icon is displayed.

For both onboard and microSD memory, the player automatically bookmarks the last file played and the position within that file when the mode is changed or the player is turned off.

<sup>1</sup>*The Pause function is only available during audio playback.*



<sup>2</sup>*If the player is left paused for more than 15 minutes, it will turn itself off.*

## EARPHONES, SPEAKERS AND VOLUME

---

Insert earphone or speaker plug into the 3.5mm stereo audio jack on the bottom of the unit. When an audio device is connected, the internal speaker will turn off and then turn back on when it is disconnected.

<sup>1</sup>While an audio device is connected, the earphone icon  is displayed on the screen.

Click  or  to decrease or increase volume one level.

<sup>2</sup>The first click automatically displays the volume adjustment screen.



Press and hold will continue to decrease/increase until the minimum (00)<sup>6</sup> or maximum (10) is reached. When the volume is set to minimum or maximum a chime is played.

The volume will remain set at this level even after the player is turned off and restarted.

After 1 second of inactivity, the volume screen will timeout and return to the previous screen.

<sup>3</sup>Separate volume levels are maintained for audio playback and radio.

<sup>4</sup>When an audio device is removed during audio playback, the player enters Pause Mode.





<sup>5</sup>Some earphones with built-in controls may not work properly.

<sup>6</sup>Volume level (00) is muted.

## USING THE MICROSD CARD

---

The player can also play audio from a properly structured<sup>2</sup> microSD card. With the player facing you, insert the card with the brass contacts showing until it locks in place.

Once a card is loaded, the "SD" icon () appears on the screen. To change to microSD playback, click  to display the Main Menu. Navigate to the microSD symbol using  or  and click  again. Playback will now begin from the card.

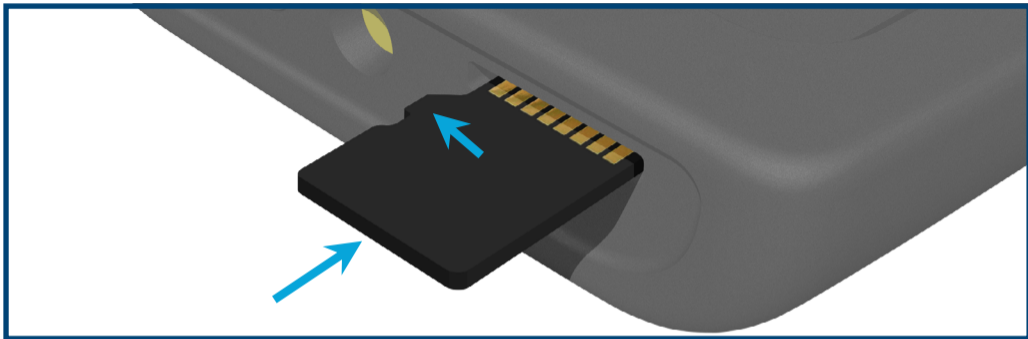

To remove a card, gently push it in. The reader will unlock and push it out so you can remove it. If the player was in playback mode from the card when removed, it will display "No microSD" and enter the Playback Screen. If any other function was active, it will continue with no change.

You can view, format and prepare an SD card while loaded in the player's microSD card reader when the player is connected to a Computer using a USB to micro-USB cable. You may also do the same with the card loaded in a microSD adaptor connected to a Computer.

<sup>1</sup>*Whenever a microSD card is inserted or removed a chime is played.*



<sup>2</sup>*Content on a microSD card must be encrypted to work on this player. Contact your sales representative for details.*

## RESETTING PLAYER DEFAULTS

---

The player's default settings may be reset at any time and at the following levels:







- Onboard Playback: delete all onboard bookmarks
- microSD Playback: delete all microSD bookmarks
- Radio - by individual band: delete last frequency, reset programmable buttons
- Speed Control: reset speed to normal (0)
- Full reset: all the above + reset volume to normal (6)

The Main Menu offers a sub-menu  of mode reset screens. From the sub-menu, choose the mode reset icon  for each of the above.

## FULL PLAYER RESET

---

To perform a **full** reset of the player do the following:



- Click  to enter the Main Menu.
- Press and hold  and  together for 2 seconds.
- The full reset menu is displayed: 
- Highlight and select the confirmation icon .
- The confirmation menu is displayed. Select the tick icon . 
- "Device Reset Successful!" is displayed.

## THE MENU SYSTEM

---



The player provides an interactive menu system that works together with the LCD screen. The menu is controlled by the buttons illustrated below. For convenience, they are accented in red on the keypad.



Menu mode and the Main Menu may be activated at any time by a click on . Navigation among menu items is by a click on either  (move left) or  (move right).

Movement among a menu's items can loop to reduce button clicks. For example, a click on  while highlighting the last (right-most) icon will move to the first (left most) icon in the menu.

Once a menu item is highlighted (background is dark), selection is made by a click on .

In each menu, the  icon is always the first option. Selecting  will always return to the previous screen.

You may also click  to exit any screen but without saving changes.

# THE MENU SYSTEM SCREENS

---

## Main Menu

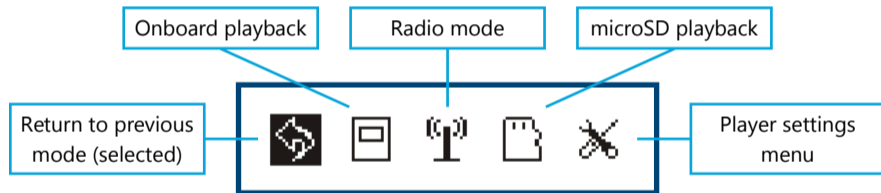



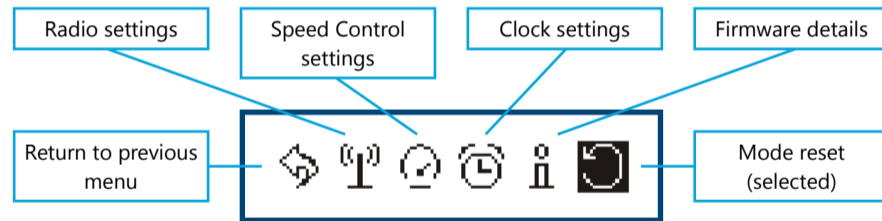



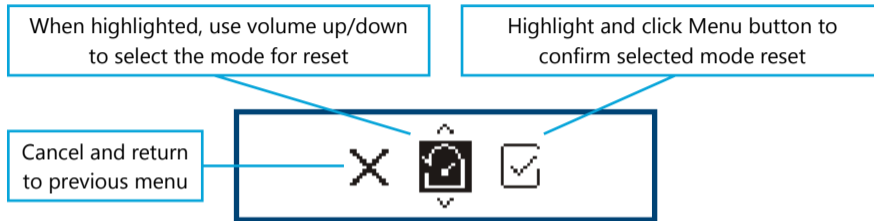

## Player Settings Menu









## Mode Reset Screen

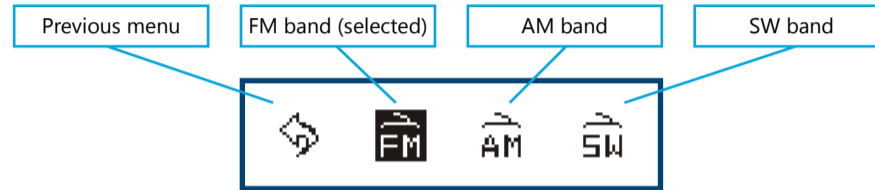

- Select the mode icon  using  or .
- Once selected, use  or  to change the mode for reset.
- Then select the confirm icon  and click .
- A confirmation message for the mode that is reset is displayed.

## Radio Settings Screen (for band spacing)



- Using  or  navigate to the band desired and click .
- The individual spacing menu will display for the band selected.

## Radio Band Spacing Screen

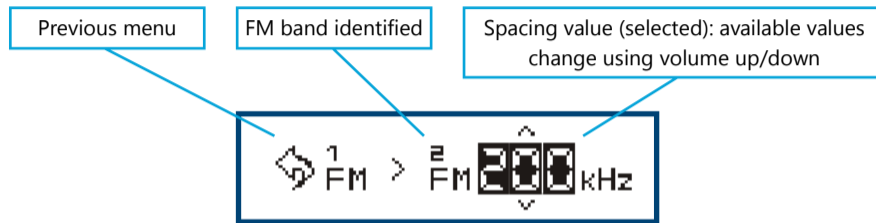

- Select the spacing value using ◀ or ▶.
- Use - or + to adjust spacing value.
- Select ↻ and click ⚙ to save the setting.

- Once the spacing value is set, scanning within that band will skip by the value specified.
- This menu is typical for all 3 radio bands. The spacing options for each band are as follows:

**FM:** 100, 200 kHz

**AM:** 1, 5, 9, 10 kHz

**SW:** 5, 10 kHz

## Speed Control Settings Screen

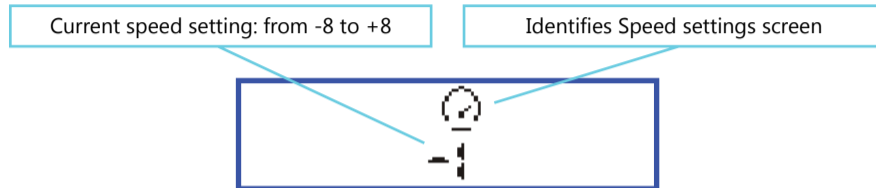



- Adjust speed setting using or .
- Click to exit and save the setting.

<sup>1</sup>*Speed Control only works correctly with MP3, WAV and WMA type audio files!*

## Clock Settings Screen



- Select the item desired using or .
- Once the item is selected<sup>1</sup>, use or to adjust the value.
- Select the icon to exit. If changes were made, they will be saved and take effect immediately.

<sup>1</sup>The  $\wedge$   $\vee$  symbols will appear above and below the item to indicate that the   buttons are active.

### Firmware Details Screen

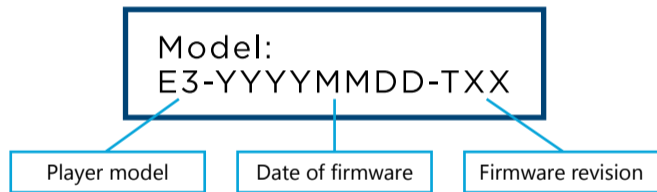



- For customer support reasons, the player will display its current firmware release.
- This screen will time-out automatically after 2 seconds.

- To verify that your player has the most recent firmware update and that you have the current user manual, please visit: [megavoice.com/audio-bible/envoy-3-equip](http://megavoice.com/audio-bible/envoy-3-equip)

## CHARGING INSTRUCTIONS

---

With proper care, the player's Lithium-Ion battery should perform well for several years. When shipped, the battery is only partially charged. Please fully charge the battery before the first use following one of the charging methods below:

-  For fastest charge, connect any standard "USB" charger (regulated +5VDC, minimum 300mA) to the micro-USB port on the bottom of the player until the charging icon<sup>2</sup> stops blinking<sup>1</sup>.
-  Plug player into any standard computer USB port using a "USB to micro-USB" cable until the charging icon<sup>2</sup> stops blinking<sup>1</sup>.

☀️ For solar charging, place the player with the solar panel facing bright sunlight for at least a full day<sup>1</sup>. *When solar charging, there is no charge indication.*

<sup>1</sup>*Actual charge time will vary according to the power source and current battery capacity.*

<sup>2</sup>*While charging, the charging icon ⚡ will appear next to the battery capacity icon in the top right corner of the screen and blink.*

## CHARGING SCREEN

---

If the player is off when connected for charging, the following screen will be displayed:



If the backlight turns off while on this screen, a 2-second press on  will turn the backlight on. An additional 2-second press can turn the player on and operate normally

while connected to an external power source.

## BATTERY CARE

---

- Avoid completely depleting the battery as this will shorten its overall lifetime and takes much longer to fully charge afterwards.
- If sunlight is the only means available for charging, it is recommended to leave the player in direct light *often* to keep the battery at least partially charged.
- When not in use and whenever possible, keep the player in a cool place, which will also help to preserve battery life.
- Before stowing the player for prolonged periods, make sure the battery is at least partially charged.

- If stored for *extended* periods, it is recommended to recharge the player at least every 6 months, in order to prevent the battery from losing its ability to recharge.
- Should the battery become defective and unable to accept a charge, it is still possible to operate the player using a USB cable connected to a computer or an electric charger. If sunlight is the only source for power/charging, please replace the battery.

## CHARGING/COMMUNICATION MODES

---

When the player is **off** and a charge-only cable is connected:

- The player will enter charging mode and the charge screen is displayed.



- When the cable is disconnected, charging stops and the player remains off.

When the player is **on** and a charge-only cable is connected:

- The current function will continue uninterrupted but the charge icon  is displayed.
- The icon will blink while charging and stop blinking once fully charged.
- When the cable is disconnected, the icon is hidden, charging will cease and the current function continues.

When the player is **off** and a data-only or SLS cable is connected:

- The computer connection screen is displayed.



- Access to the onboard memory and/or microSD is possible.

- When the cable is disconnected, the player remains off.

When the player is **on** and a data-only or SLS cable is connected:

- The current function will continue uninterrupted but the charge icon  is displayed.
- The icon will blink while charging and stop blinking once fully charged.
- When the cable is disconnected, the icon is hidden, charging will cease and the current function continues.

<sup>1</sup>*Changing to Computer Communication mode is essential to allow programming of the Player and/or Firmware.*

<sup>2</sup>*Whenever any USB cable is connected or disconnected a chime will be played.*

## PROBLEMS WITH THE PLAYER?

---

If the unit will not turn on, please try the following:

1. Make sure the battery is charged according to CHARGING INSTRUCTIONS.
2. If the battery is OK, force a reboot of the player by holding  for about 10 seconds. The player should restart automatically.
3. If #2 fails, reset the player by gently inserting the end of a paper clip for a few seconds into the reset hole on the back of the player, just above the left-most screw holding the back panel. This is the same as disconnecting/reconnecting the battery. The player should restart automatically.
4. If none of the above succeeded, please contact your sales representative for support.

## WARNINGS

---

- Care must be taken to set the volume at the lowest level that can be heard comfortably. Prolonged exposure to loud sound can cause gradual hearing loss.
- DO NOT expose player or battery to fire or extreme heat.
- Stop using player if you observe abnormal heat, odor, discoloration, leakage or deformation, especially near battery. Refer to a qualified technician for service.
- If the battery is removed from the player, handle it with care. Keep the exposed battery out of reach of children. DO NOT burn, puncture, disassemble, or modify battery.
- If battery leaks, dispose of it carefully in accordance with all local laws. Wash any skin

or clothing exposed to battery liquid and avoid swallowing or contact with eyes. In the case of swallowing or contact with eyes, seek medical care immediately.

## RESET BUTTON

---

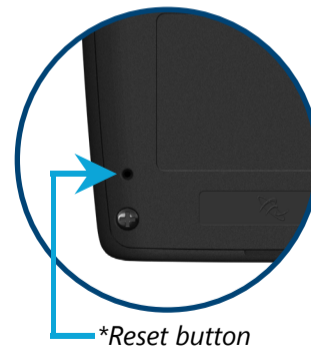





© 2021 MegaVoice Ltd. Made in China

MV - Envoy 3 Equip Plus - UM - Book - Eng - 2021.07.11-1.1.0